

3092806 RE / (St.: 01.2015) 01.2015

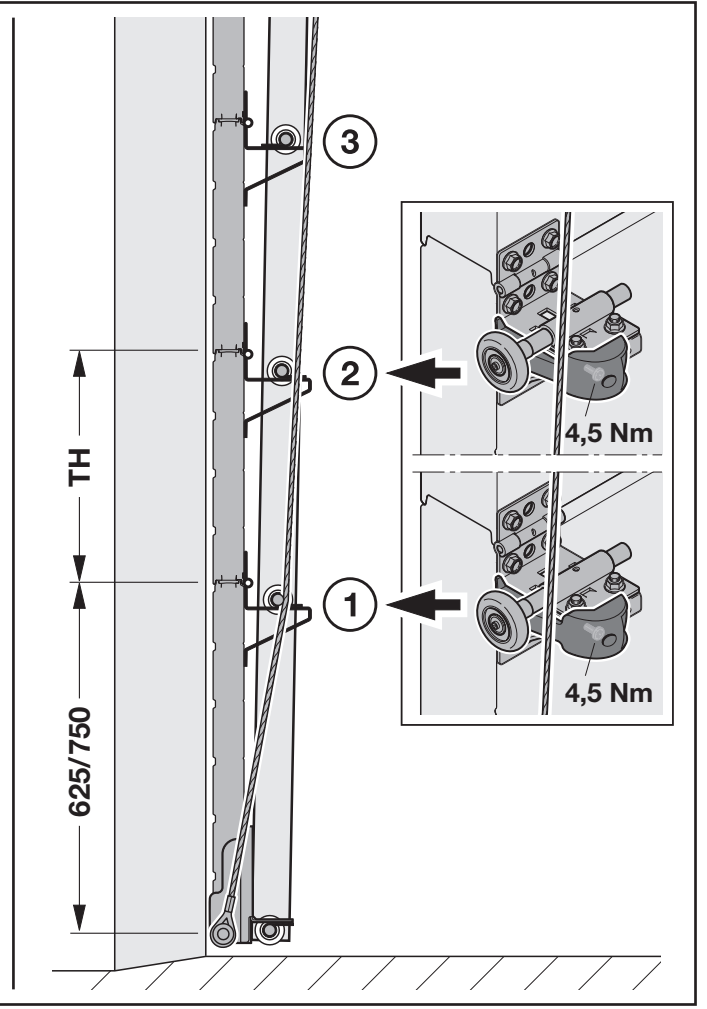

3092806 RE / (St.: 01.2015) 01.2015

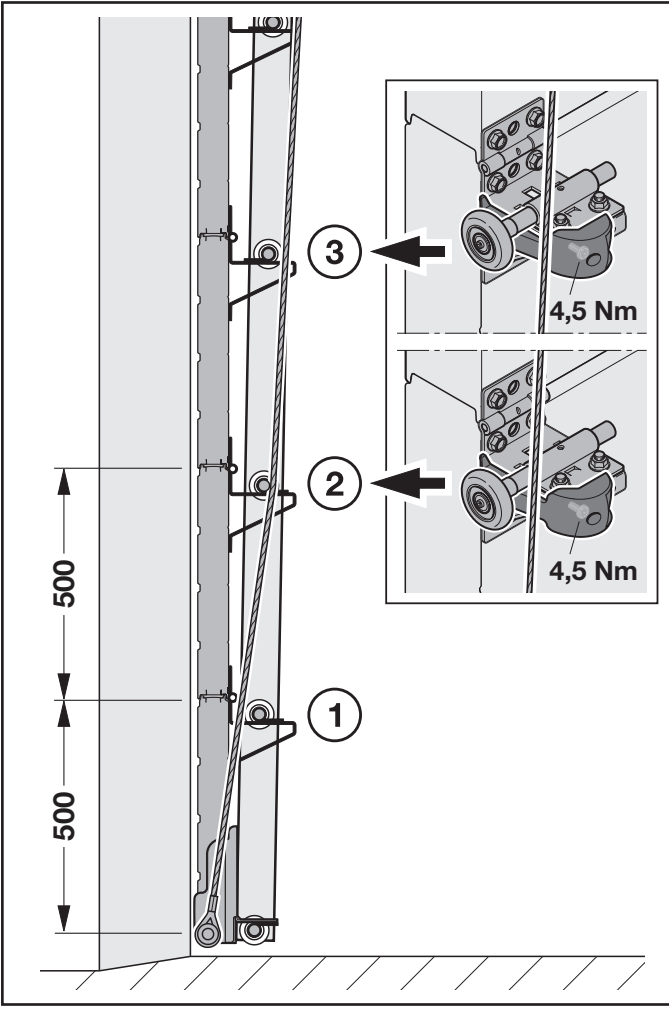